

FEATURES

- Field-Bus remote data acquisition
- Modbus Slave device on RS-485
- Modbus RTU/ Modbus ASCII protocol
- 8 digital inputs
- 8 digital outputs type PNP
- Watch-Dog alarm
- 2000 Vac galvanic isolation on all ways
- High accuracy
- UL / CE mark
- In compliance to EN-50022 DIN rail mounting



GENERAL DESCRIPTION

The device DAT 3188/8 is able to acquire up to 8 digital inputs and to drive up to 8 transistor outputs type PNP. The data are transmitted with MODBUS RTU/MODBUS ASCII protocol on the RS-485 network (RS-232 interface is available)..

The device guarantees high accuracy and stable measure versus time and temperature.

To ensure the plant safety, two Watch-Dog timer alarms are provided.

The isolation between the parts of circuit removes eventual ground-loop effects, allowing the use of the device even in the heavy environmental conditions.

The DAT 3188/8 is in compliance with the Directive 2004/108/EC on the electromagnetic compatibility.

The DAT 3188/8 is in compliance with the Directive UL 61010-1 for US market and with the Directive CSA C22.2 No 61010-1 for the Canadian market.

The device is housed in a rough self-extinguishing plastic container which, thanks to its thin profile of 17.5mm only, allows a high density mounting on EN-50022 standard DIN rail.

COMMUNICATION PROTOCOLS

The DAT3188/8 is designed to work with the MODBUS RTU/MODBUS ASCII protocol: standard protocol in field-bus; allows to directly interface DAT3000 series devices to the larger part of PLCs and SCADA applications available on the market.

For the protocol instructions, refer to the User Guide of the device.

USER INSTRUCTIONS

Before to install the device, please read the "Installation Instruction" section.

If the module configuration is unknown, with device powered off, connect the INIT terminal to the GND terminal (ground), at the next power on the device will be auto-configured in the default settings (refer to the User Guide of the device).

Connect power supply, serial bus, digital inputs and outputs as shown in the "Wiring" section.

The "PWR" LED state depends on the working condition of the device: see the "Light Signalling" section to verify the device working state.

To perform configuration and calibration operations, read the instructions in the User Guide of the device.

To simplify handling or replacing of the device, it is possible to remove the wired terminals even with the device powered.

TECHNICAL SPECIFICATIONS (Typical @ 25 °C and under nominal conditions)

DIGITAL INPUTS		DIGITAL OUTPUTS		POWER SUPPLY	
Number of Channels	8	Number of Channels	8	Power supply voltage	10 .. 30 Vdc
Input voltage (bipolar)	OFF State : 0+3 V ON State : 10+30 V	Type	PNP	Reverse polarity protection	60 Vdc max
Input Impedance	4.7 KOhm	Voltage	10.5+30 Vdc	Current consumption	45 mA max.
Sample time	5 ms	Max. Load	500 mA per channel(*) 1 A per module	ISOLATION	
		Inductive Load	48 Ω – 2H max	Between all ways	
		(*) Protection against over-current and over-temperature Short circuit current 1.7 A max.		2000 Vac, 50 Hz, 1 min	
		Data Transmission		ENVIRONMENTAL CONDITIONS	
		Baud Rate	115.2 Kbps	Operative Temperature	-10°C .. +60°C
		Max. distance	1.2 Km – 4000 ft	UL Operative Temperature	-10°C .. +40°C
				Storage Temperature	-40°C.. +85°C
				Humidity (not condensed)	0 .. 90 %
				Maximum Altitude	2000 m
				Installation	Indoor
				Category of installation	II
				Pollution Degree	2
				MECHANICAL SPECIFICATIONS	
				Material	Self-extinguish plastic
				IP Code	IP20
				Wiring	wires with diameter 0.8÷2.1 mm ² /AWG 14-18
				Tightening Torque	0.5 N m
				Mounting	in compliance to DIN rail standard EN-50022
				Weight	about 150 g.
				CERTIFICATIONS	
				EMC (for industrial environments)	
				Immunity	EN 61000-6-2
				Emission	EN 61000-6-4
				UL	
				US Standard	UL 61010-1
				Canadian Standard	CSA C22.2 No 61010-1
				CCN	NRAQ/NRAQ7
				Typology	Open Type device
				Classification	Industrial Control Equipment
				File Number	E352854

INSTALLATION INSTRUCTIONS

The DAT 3188/8 is suitable to be mounted on DIN rail, in vertical position. For a correct working and a long life of the device, read the following indications.

In case of the devices are mounted side by side, please leave about 5mm between in the following situations:

- Temperature in the cabinet higher than 45 °C and high supply voltage (>27Vdc).

Avoid to place raceways or other objects which could obstruct the ventilation slits. It is suggested to avoid that devices are mounted above appliances generating heat; their ideal place should be in the lower part of the panel.

Avoid to install the devices in a site where vibrations are present.

It is recommended to use shielded cable for connecting signals. The shield must be connected to an earth wire provided for this purpose. Moreover it is suggested to avoid routing conductors near power signal cables.

CABLING

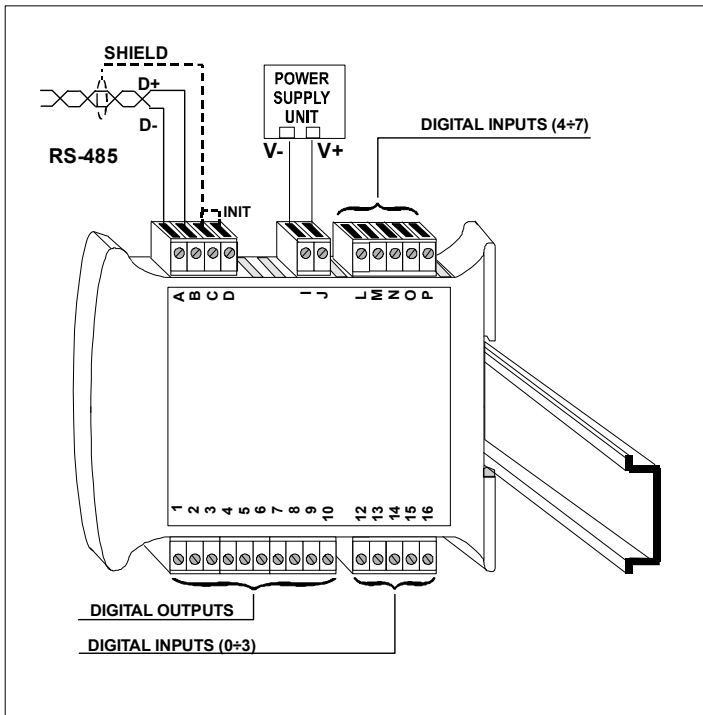

LIGHT SIGNALLING

LED	COLOUR	STATE	DESCRIPTION
PWR	GREEN	ON	Device powered
		OFF	Device not powered or wrong RS-485 connection
		RAPID BLINK	Communication in progress (the blink frequency depends to the Baud-rate)
		SLOW BLINK	~1 sec. - Watch-Dog Alarm condition

MECHANICAL DIMENSIONS (mm)

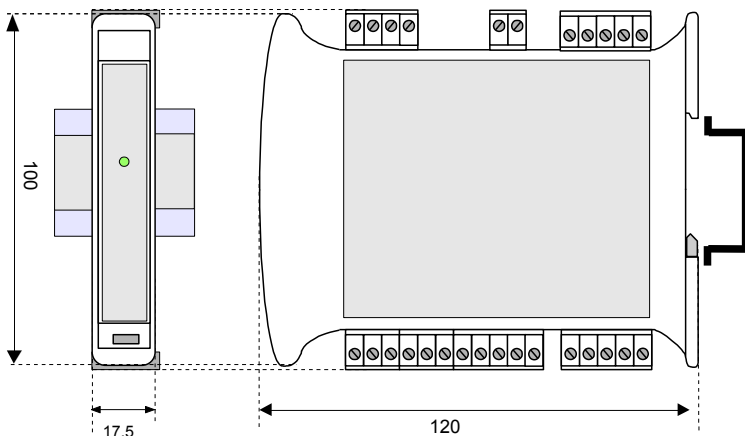

WIRING

DIGITAL INPUTS

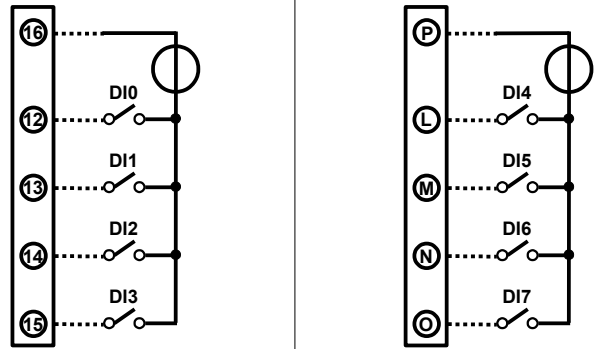

NOTE: Input channels 0÷3 and 4÷7 are not insulated between them

DIGITAL OUTPUTS

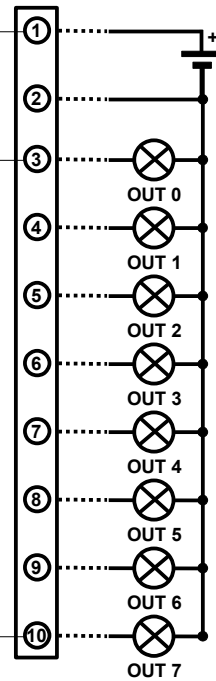

NOTE: Output channels are not insulated between them

RS-485 NETWORK

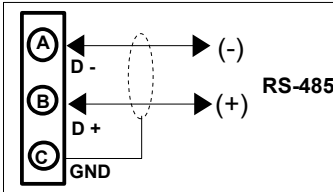

RS-232 NETWORK

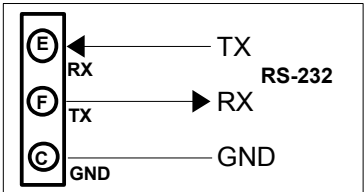

POWER SUPPLY (*)

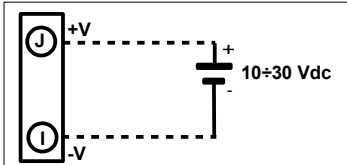

INIT

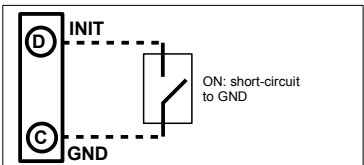

(*) Note: for UL installation the device must be powered using a power supply unit classified NEC class 2 or SELV

ISOLATION STRUCTURE

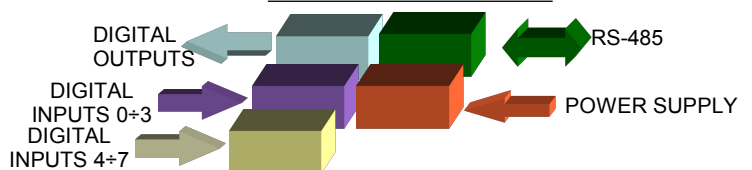

HOW TO ORDER

In the order phase it is mandatory to specify interface type (RS485 or RS232).

DAT 3188 / 8 / 485

Interface type:
485 : RS-485
232 : RS-232

■ = Mandatory
□ = Optional